

FELCO 50 - Green

- Hoof clippers

Made in Switzerland by FELCO



220mm/8.7in. 305g/10.8oz.



- > **Reliable:** comfortable, light, sturdy handles made of forged aluminium with a lifetime guarantee* / blade and screw-mounted anvil blade made of high-quality hardened steel / clean, precise cut / all parts can be replaced
- > **Efficient:** easy, durable cutting adjustment / Protection against the risk of hoof infections thanks to blades coated with XYLAN®
- > **Ergonomic:** hand and wrist protection, and optimisation of the force exerted are provided by the revolving handle, the angled head and the cushion-shock absorber / non-slip coating

RECOMMENDED FOR

Our recommendation (★ = Recommended, ★★ = Strongly recommended, ★★★ = Best fit)

Ovine and caprine rearing	★★★
Small hand	★★★
Average-sized hand	★★★
Large hand	★★★
Right-handed	★★★
Left-handed	★★★

CUTTING CAPACITIES

Material

Maximum cutting diameter

Sheep / goat hooves



ACCESSORIES



FELCO 902
Sharpening tool
Sharpening stone



FELCO 903
Sharpening tool
Sharpener



FELCO 910
Holster
Leather - With belt loop and clip



FELCO 912
Holster
Leather - With belt clip



FELCO 980
Maintenance product
Spray







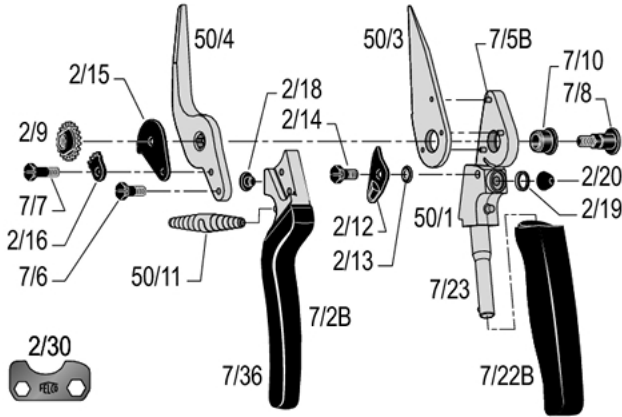































FELCO 990
Maintenance product
Grease

SPARE PARTS



FELCO	REF.	Designation	Composition	UCC Barcode
	2/30	Adjustment key	1x 2/30	
	50/3	Blade	1x 50/3	
	50/4	Anvil-blade	1x 50/4	
	7/90	Kit	1x 7/7 + 1x 2/16 + 1x 2/9 + 1x 7/8	
	2/92	Kit	1x 2/15 + 1x 2/18 + 1x 2/14 + 1x 2/12 + 1x 2/13 + 1x 2/20	
	2/93	Kit	4x 2/18 + 6x 2/20	
	7/94	Kit	1x 2/9 + 1x 7/8	
	50/1	Handle without blade	1x 50/1 + 1x 7/23 + 3x 7/5B + 1x 2/19 + 1x 2/20 + 1x 7/10 + 1x 2/13 + 1x 2/12 + 1x 2/14	
	7/2B	Handle without anvil-blade	1x 7/2B + 1x 2/18 + 1x 7/36	

	7/22B	Revolving handle	1x 7/22B	
	7/23	Axis for revolving handle	1x 7/23	
	7/36	Coating for anvil-blade / anvil handle	1x 7/36	
	7/5B	Rivet for blade	1x 7/5B	
	7/6	Screw for anvil-blade	1x 7/6	
	7/8	Bolt	1x 7/8	
	2/9	Nut	1x 2/9	
	7/10	Bush	1x 7/10	
	50/11	White spring	1x 50/11	
	2/12	Thumb catch	1x 2/12	
	2/13	Spring for thumb catch	1x 2/13	
	2/14	Screw for thumb catch	1x 2/14	
	2/15	Catch plate	1x 2/15	
	2/16	Locking segment	1x 2/16	
	7/7	Screw for locking segment	1x 7/7	

	2/18	Cushion	1x 2/18	 7 83929 40159 1
	2/19	Edging	1x 2/19	 7 83929 40160 7
	2/20	Shock absorber	1x 2/20	 7 83929 40162 1

MAINTENANCE

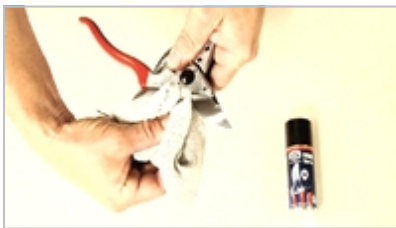

Cleaning

It is advisable to clean your tool after each use.
 If your tool is particularly dirty or subject to rusting after exposure to moisture, do not delay cleaning.



Oiling

After cleaning, it is advisable to oil the tool so as to protect it from corrosion. The oil will also unjam the tool.



Dismantling the revolving handle

It is advisable to dismantle the revolving handle on a regular basis, so that it does not become jammed.

PARTS REPLACEMENT



Changing the shock absorber

When the tool closes too abruptly during pruning, and the cushion is in good condition, the shock absorber should be changed.



Changing the cushion

When the tool closes too abruptly during pruning and the shock absorber is in good condition, the cushion must be changed.



Changing the thumb catch

When the thumb catch is damaged and loosens when used, even when the screw is readjusted, change it.



Changing the plastic coatings for handles

If the coatings are badly damaged, you can replace them.

Soak the coatings for 2 minutes in boiling water - recommended glue: Loctite 415.